

Fecha	Nombre	VERO SEBASTIÀ
Curso 2º ESO	Título Isométrica 1	

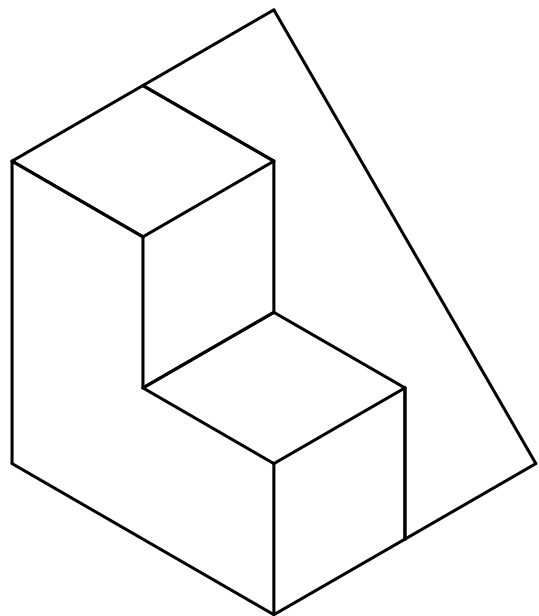

Fecha	Nombre	VERO SEBASTIÀ
Curso 2º ESO	Título Isométrica 2	

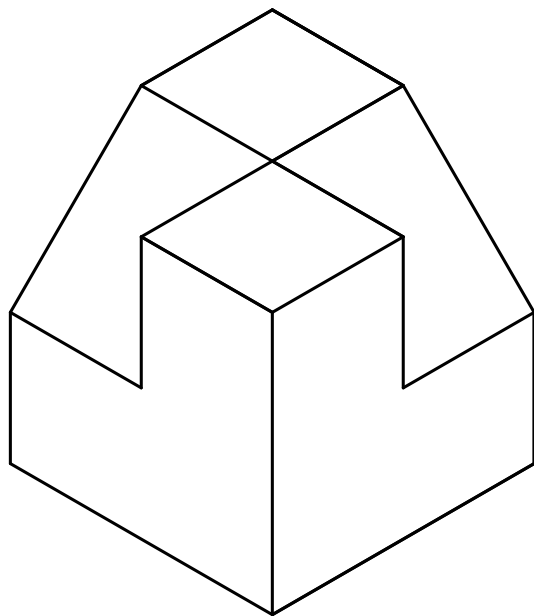
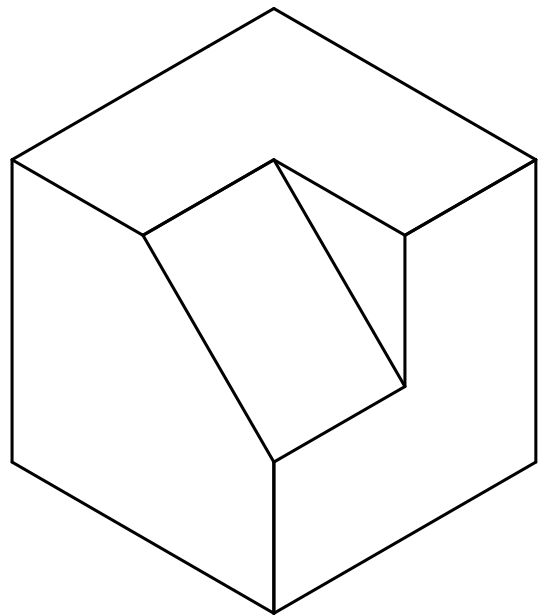
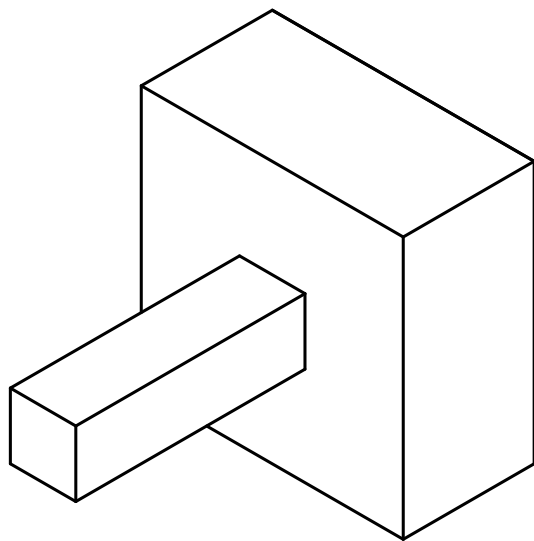
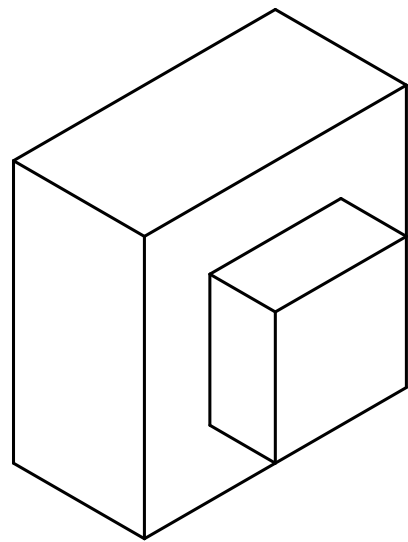
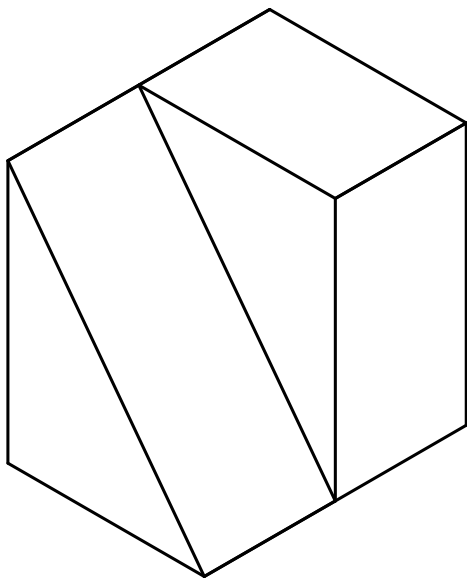
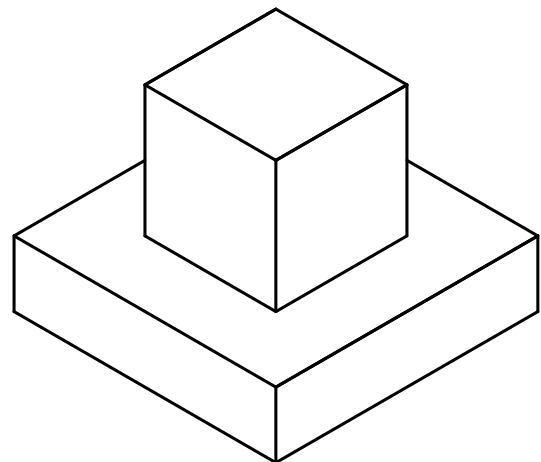
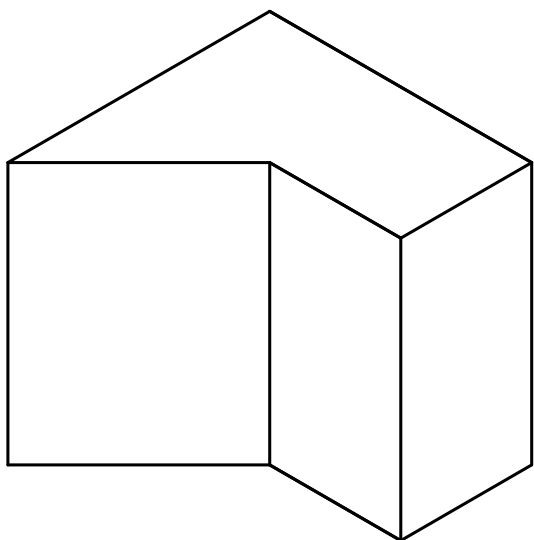
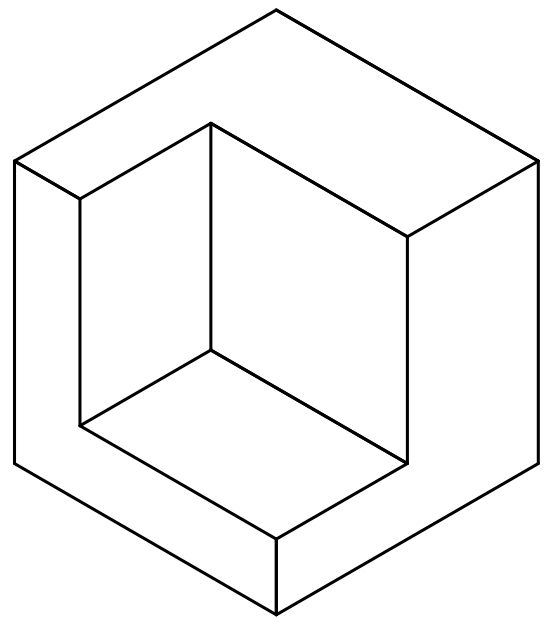
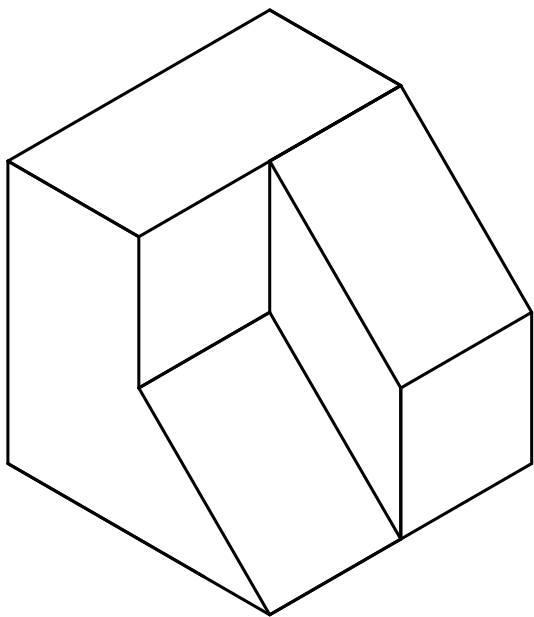
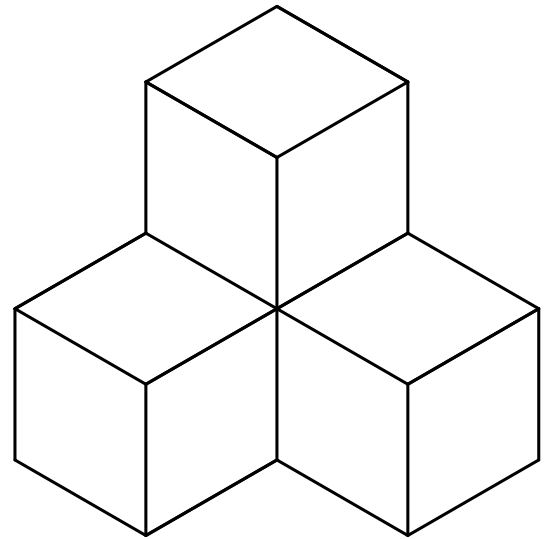
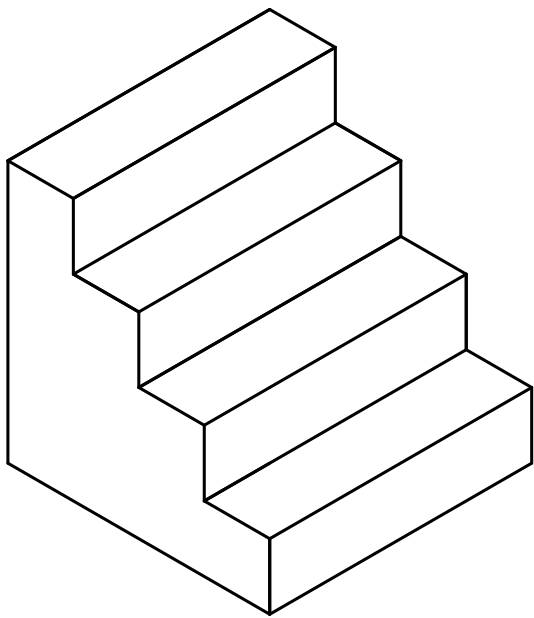

Fecha	Nombre	VERO SEBASTIÀ
Curso 2º ESO	Título Isométrica 3	