

Fecha	Nombre	VERO SEBASTIÀ
Curso 2º Bach	Título Intersección recta cuerpo 1	

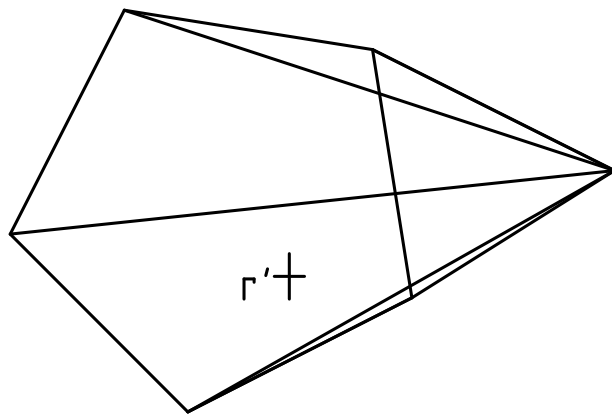

Fecha	Nombre	VERO SEBASTIÀ
Curso 2º Bach	Título Intersección recta cuerpo 2	

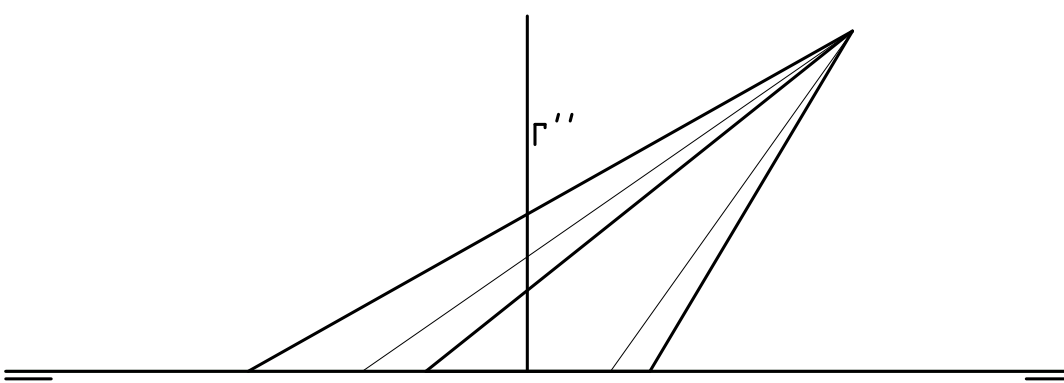
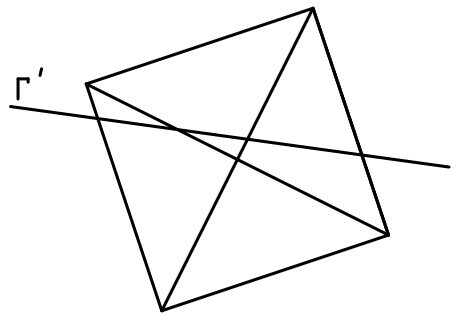
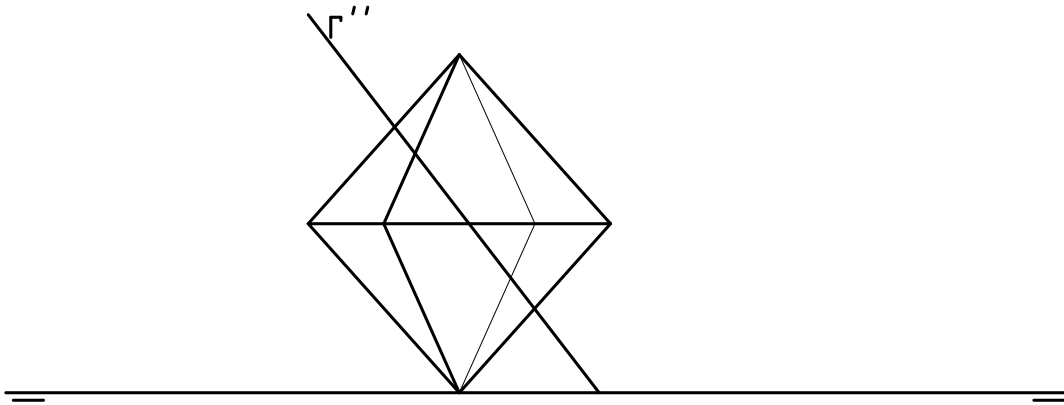
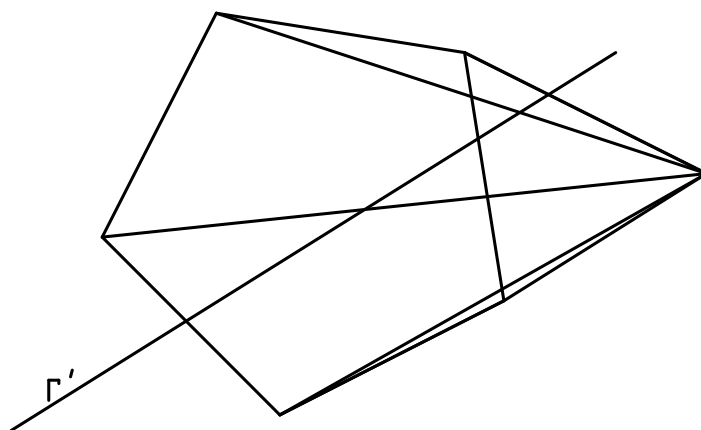
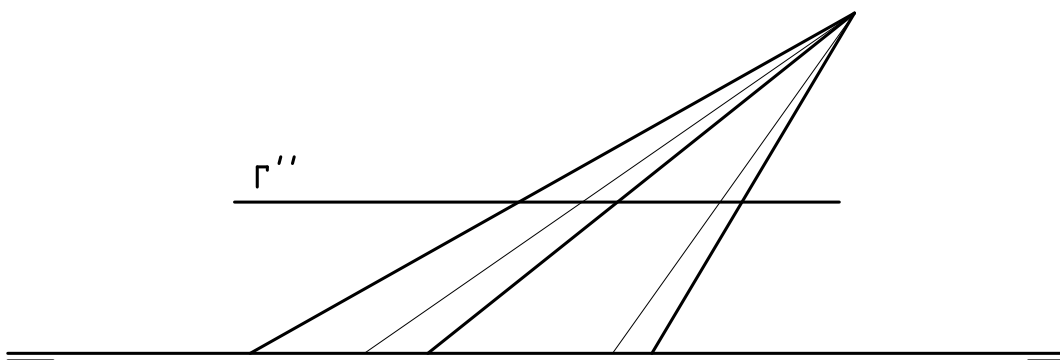
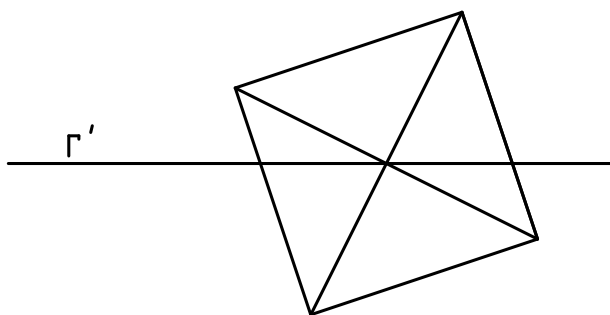
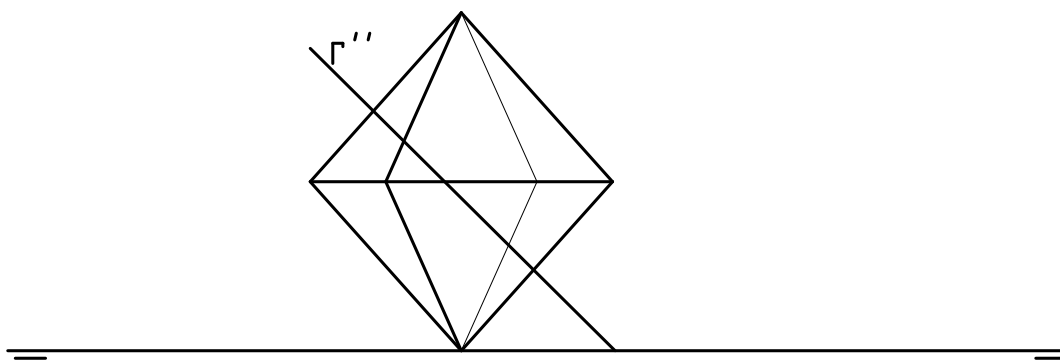

Fecha	Nombre	VERO SEBASTIÀ
Curso 2º Bach	Título Intersección recta cuerpo 3	

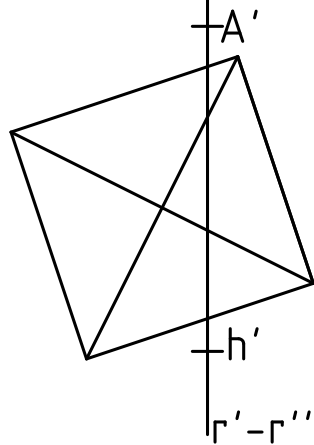
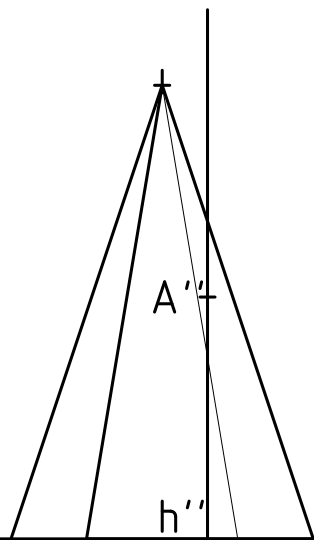
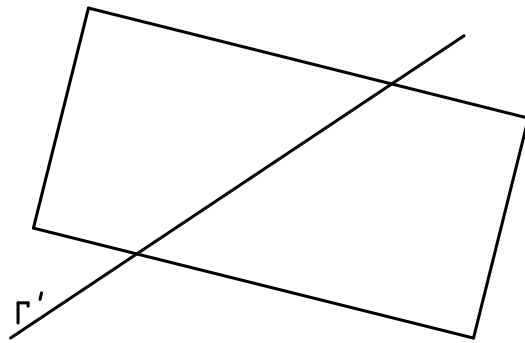
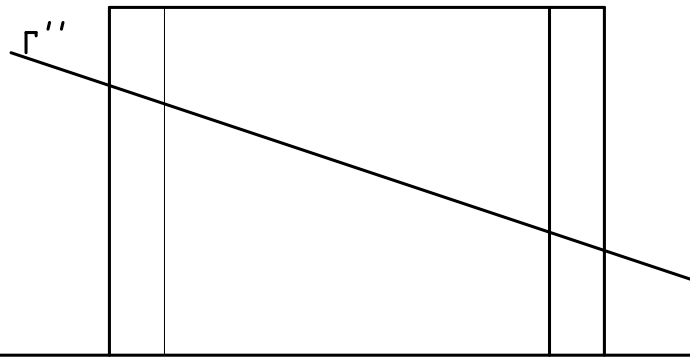

Fecha	Nombre	VERO SEBASTIÀ
Curso 2º Bach	Título Intersección recta cuerpo 4	

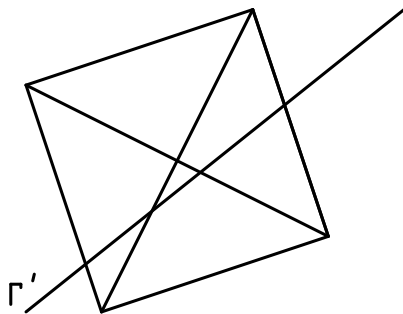
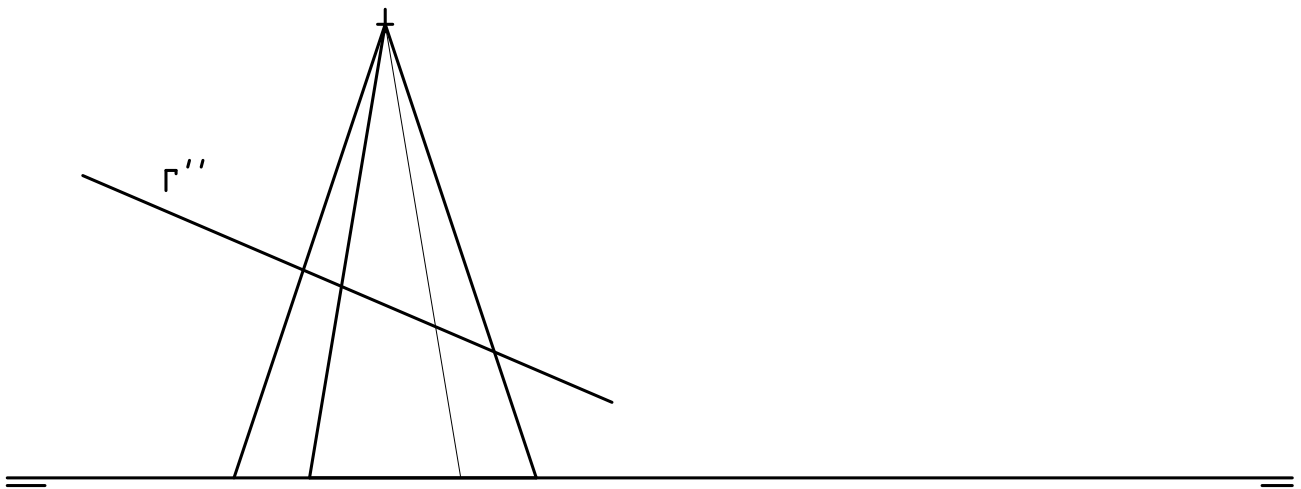
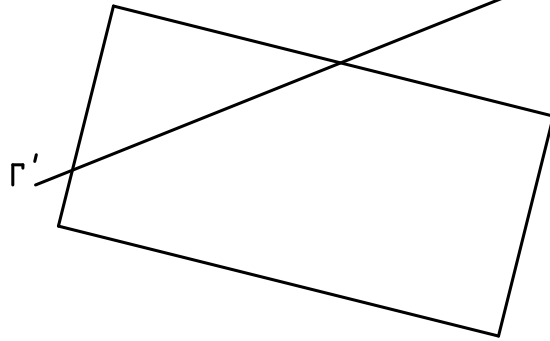
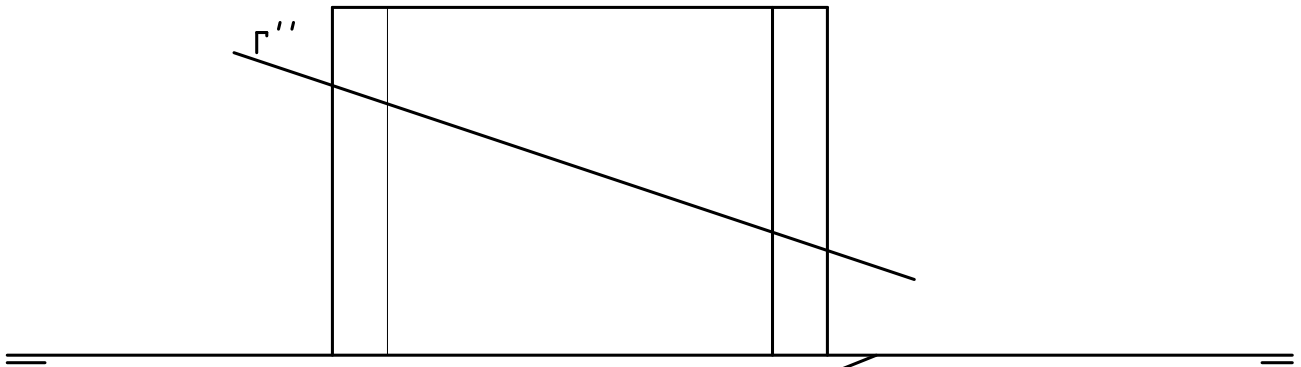

Fecha	Nombre	VERO SEBASTIÀ
Curso 2º Bach	Título Intersección recta cuerpo 5	

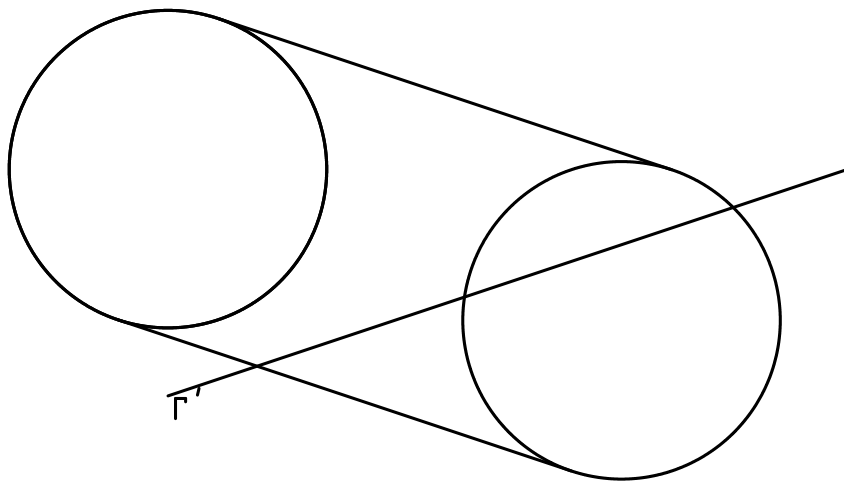
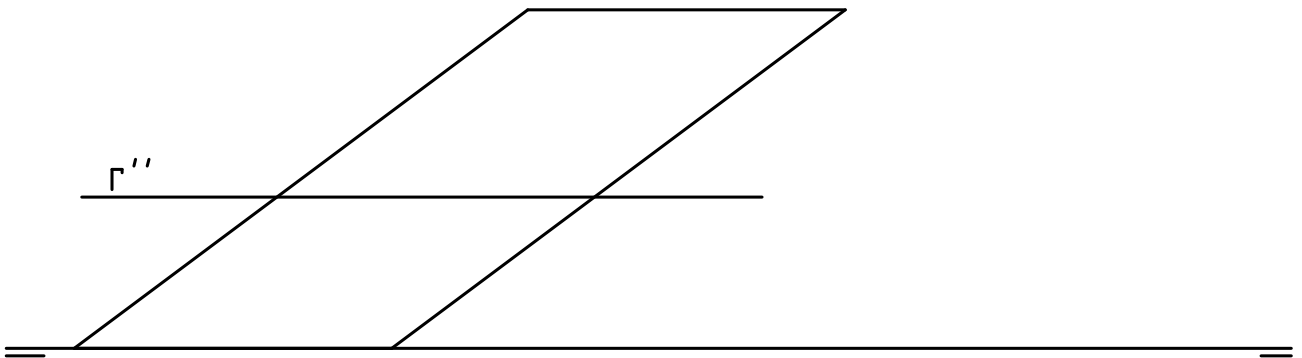
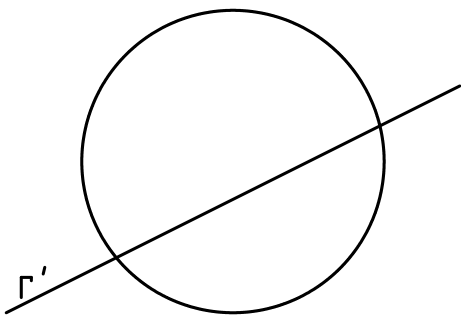
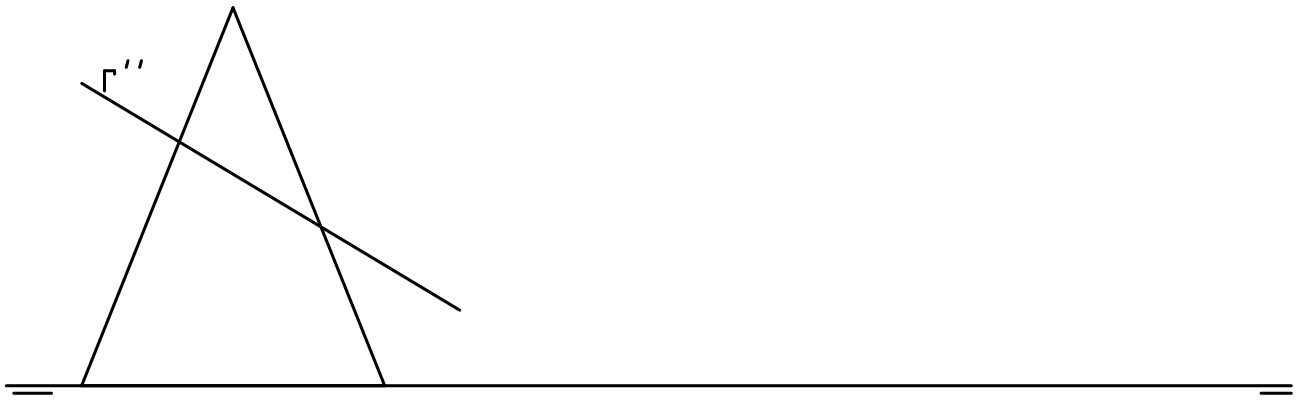

Fecha	Nombre	VERO SEBASTIÀ
Curso 2º Bach	Título Intersección recta cuerpo 6	

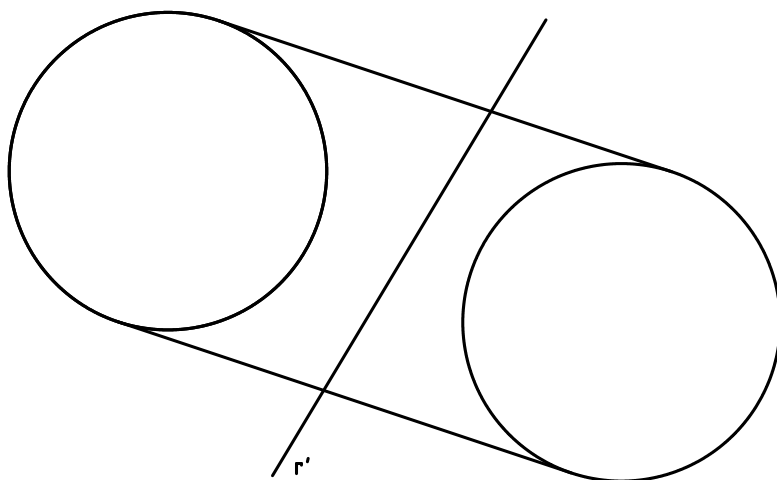
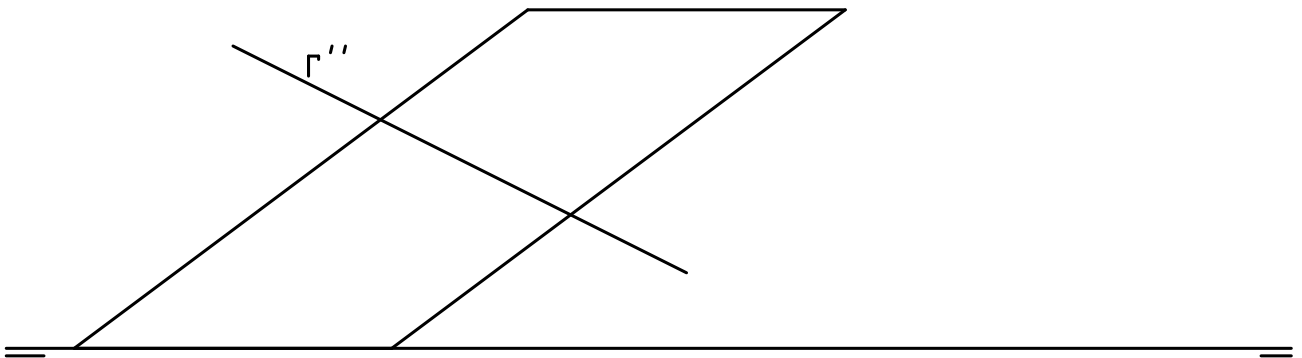
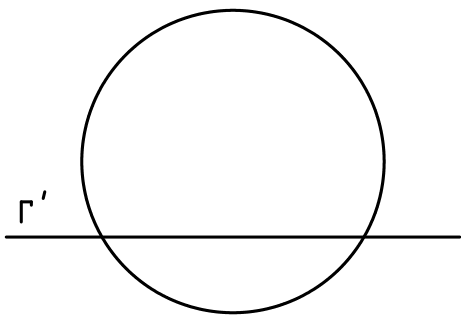
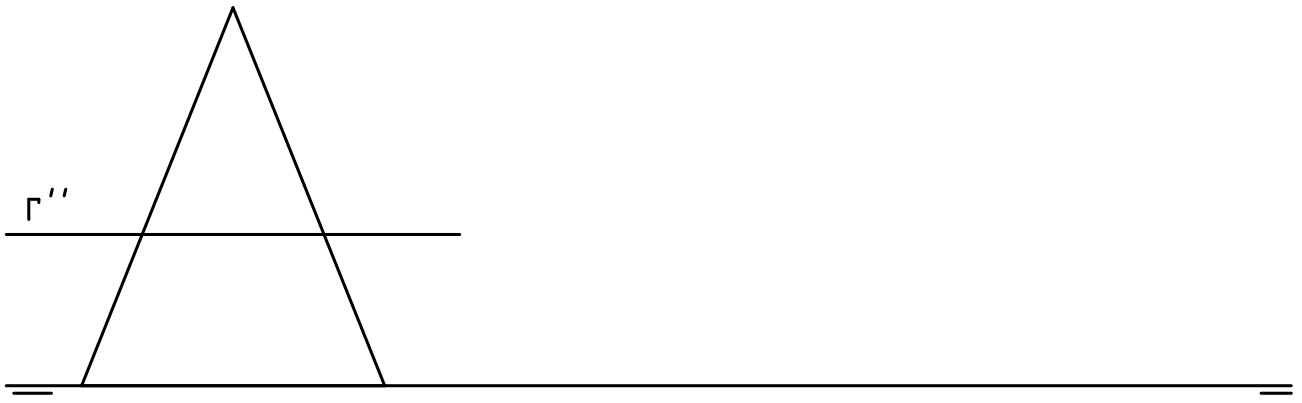

Fecha	Nombre	VERO SEBASTIÀ
Curso 2º Bach	Título Intersección recta cuerpo 7	

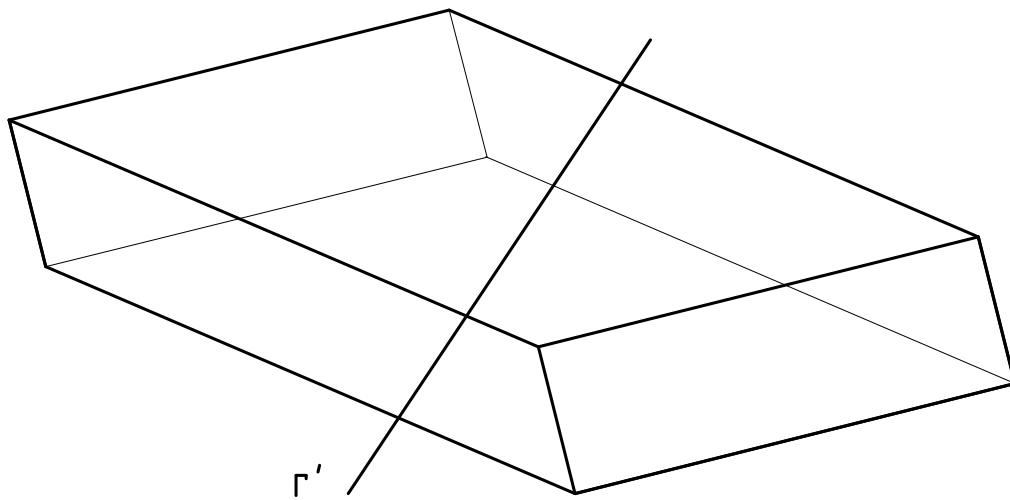
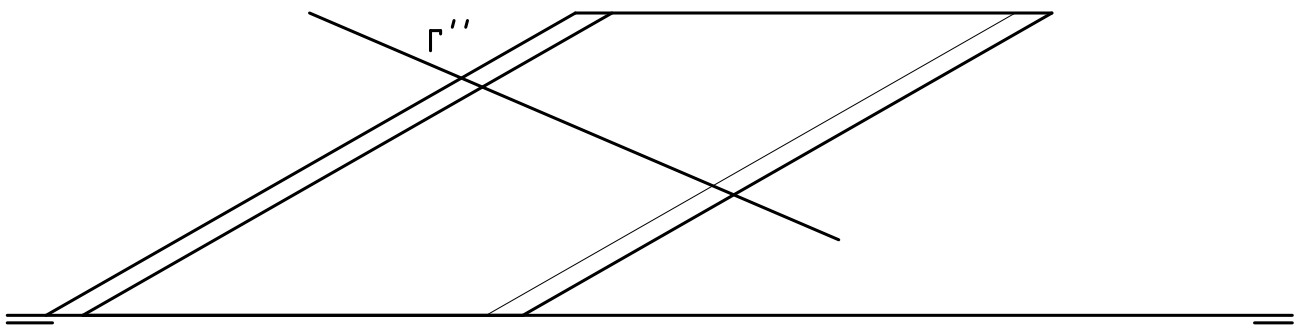
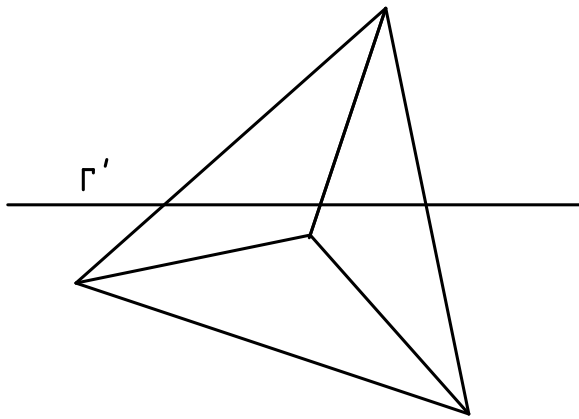
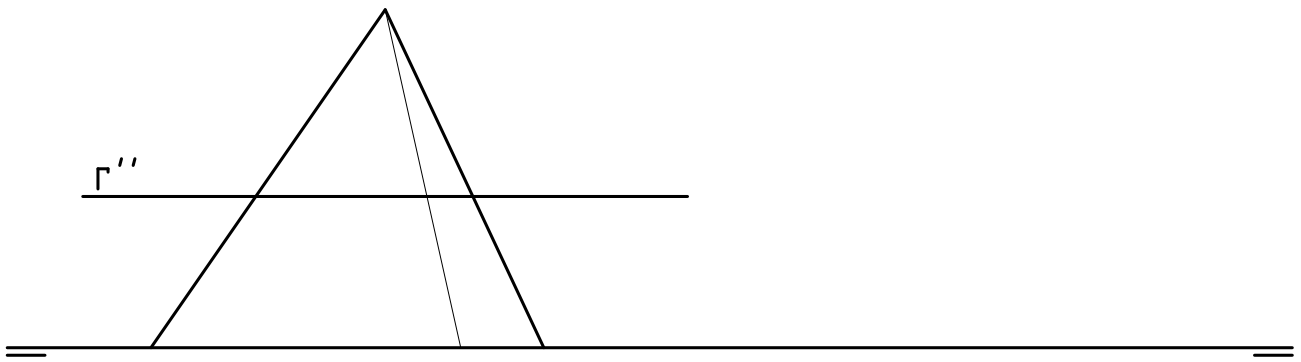

Fecha	Nombre	VERO SEBASTIÀ
Curso 2º Bach	Título Intersección recta cuerpo 8	

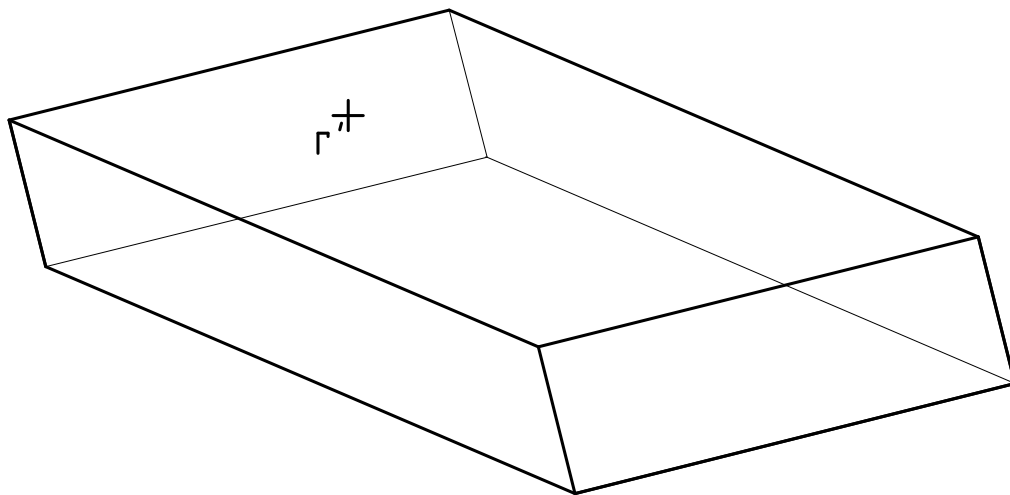
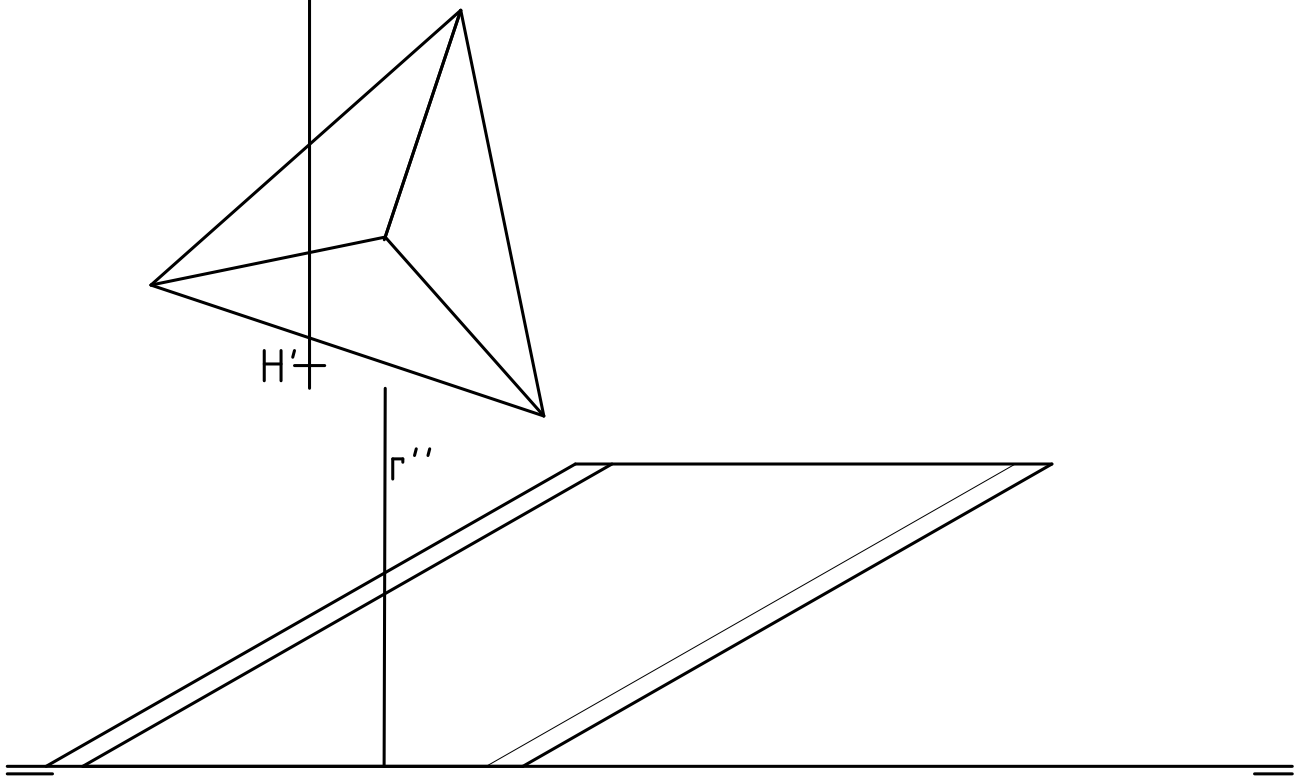
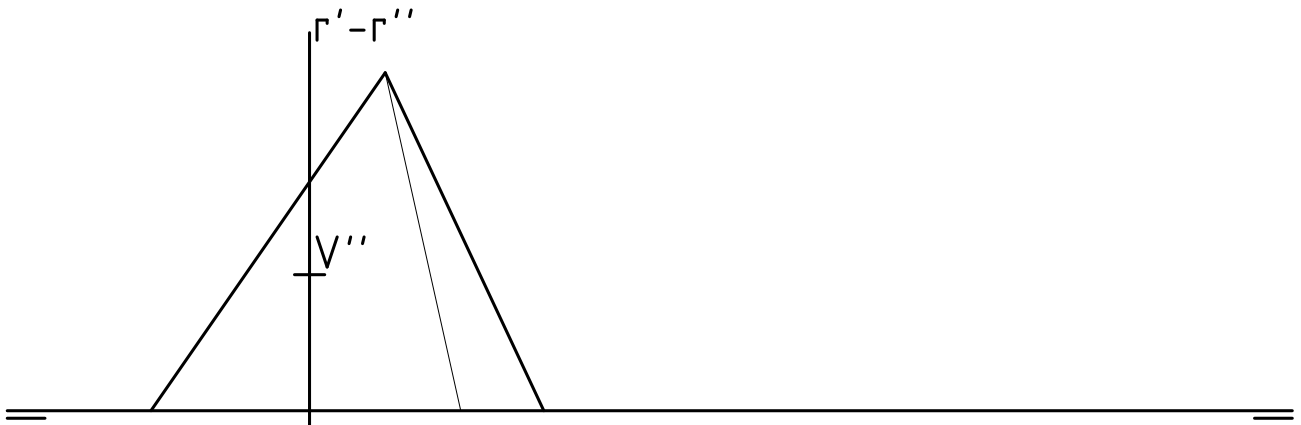

Fecha	Nombre	VERO SEBASTIÀ
Curso 2º Bach	Título Intersección recta cuerpo 9	

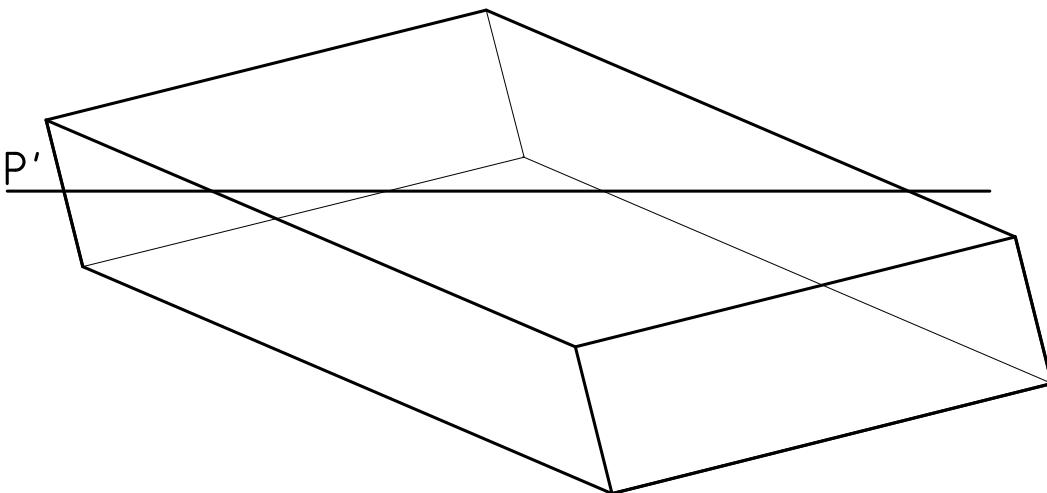
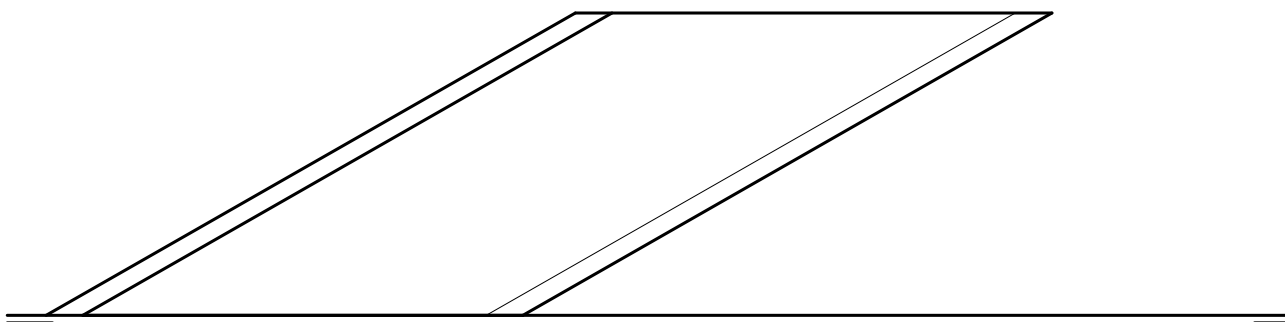
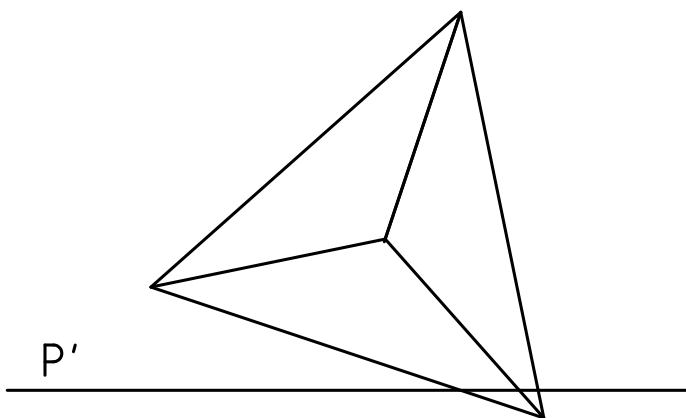
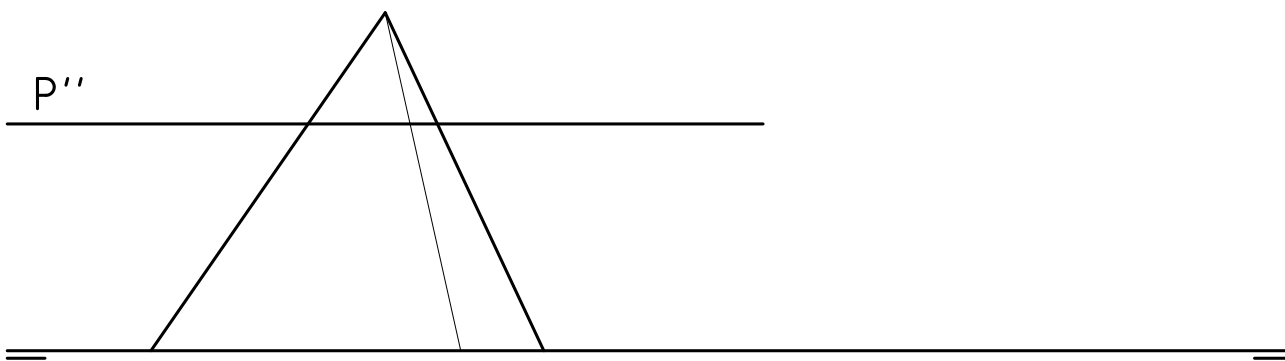

Fecha	Nombre	VERO SEBASTIÀ
Curso 2º Bach	Título Intersección plano cuerpo 10	