

Agujeros Pasantes  
 A =  $\phi 2$   
 B =  $\phi 3$   
 C =  $\phi 9$   
 D =  $\phi 1$

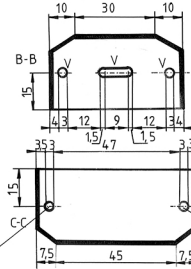

V=Agujeros pasantes

Agujero pasante

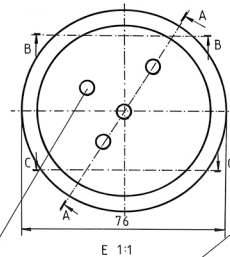
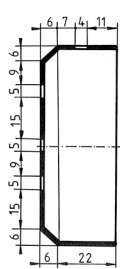
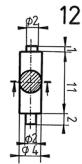
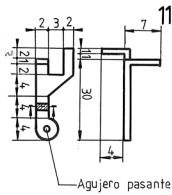
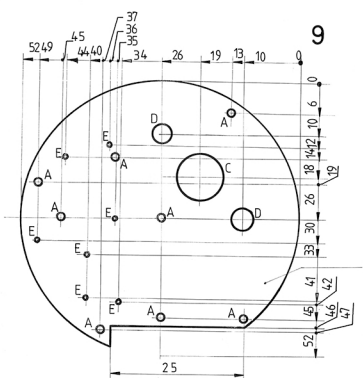
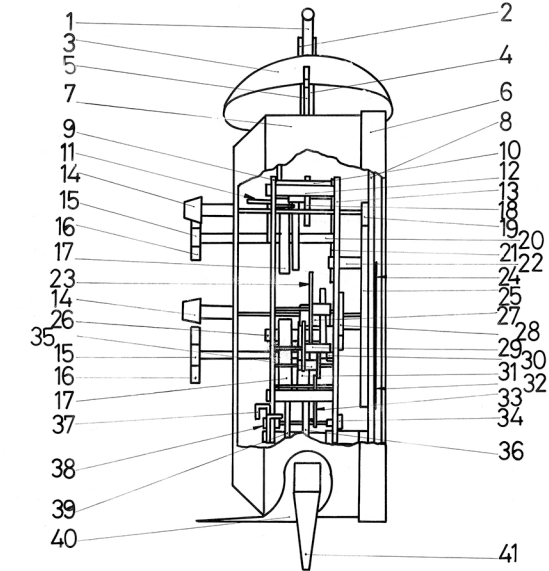
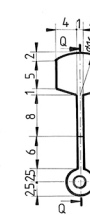

Espesor 1mm  
 Agujeros pasantes  
 A =  $\phi 2$   
 B =  $\phi 3$   
 C =  $\phi 9$   
 D =  $\phi 4$   
 E =  $\phi 1$

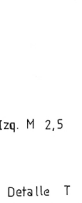
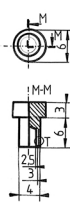
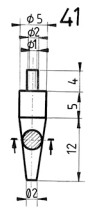
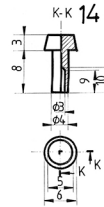
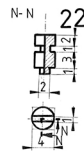
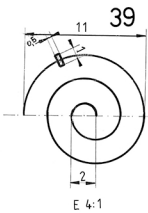

Izq. M 2,5  
 Detalle T

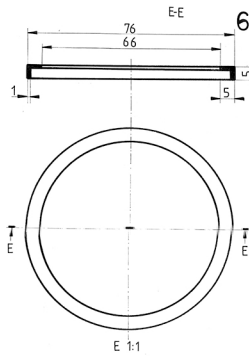
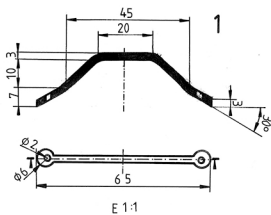

U=Agujeros pasantes

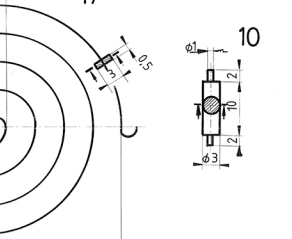
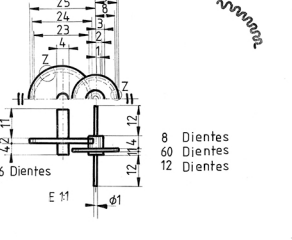
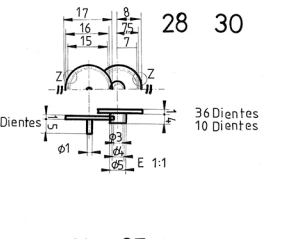
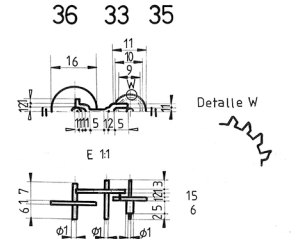
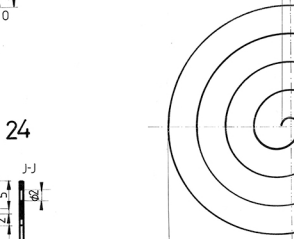
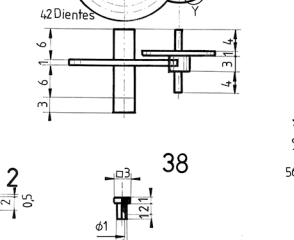
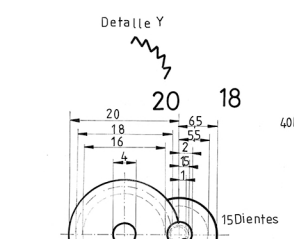
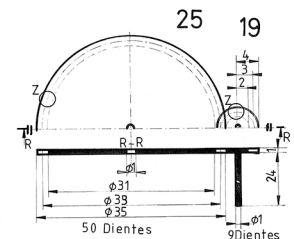
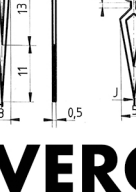
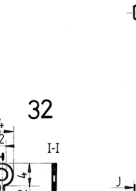
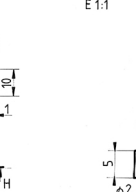
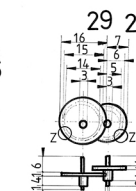
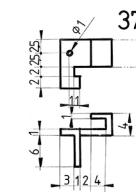
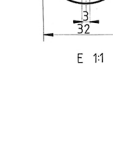
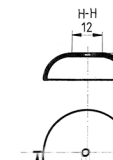
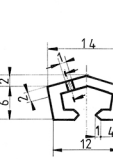
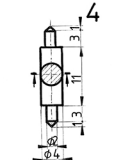
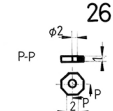
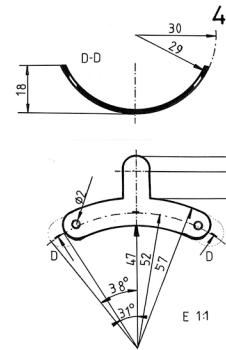
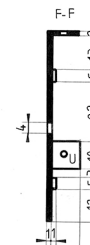
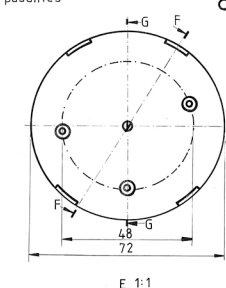
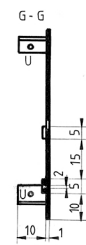

Detalle W

Detalle Y

Detalle Z

**VERO**  
**SEBASTIA.COM**

FECHA	NOMBRE	Facultad BBAA.
DIBUJADO JUN-1994	V. SEBASTIA	
E2:1 Reloj- Despertador.		